

## CITY OF CHICAGO APPROVED INDUSTRIAL EXITS

### SPECIFICATIONS

The C3 Series exit sign combines maximum value and reliability with sleek, modern styling for the most demanding architectural applications.

### CONSTRUCTION

Housing constructed of extruded aluminum. Door frame opens on end for easy access to internal components.

### MOUNTING

Universal mounting – ceiling, end, wall or back; canopy supplied. Pendant kit optional, please specify.

### FINISH

Brushed satin aluminum standard; baked polyurethane powder coat finishes are available (please specify).

### PANEL

Glass panels (Chicago Code) have red letters on white background. Letters are 6" high with 3/4" stroke. Other color combinations are available to meet local codes.

### ELECTRICAL

Incandescent—furnished with two (2) 20T6.5 double contact bayonet base lamps. Power consumption — 40 watts; average lamp life— 2,000 hours. Fluorescent—Wired with two (2) 7/9 watt ballasts and furnished with two (2) compact fluorescent lamps. Power consumption – 21.6 watts; average lamp life — 10,000 hours. Cold Cathode—Lamp provides long life and energy efficiency with excellent lumen output while offering the same color quality as fluorescent. Operating Wattage 10 Watts total Lamp Life A minimum of 50,000 hours at full lumen output



### DIMENSIONS

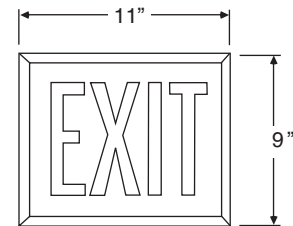

C3-1 AC Only  
Front View

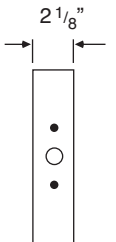

C3-1 AC Only  
Side View

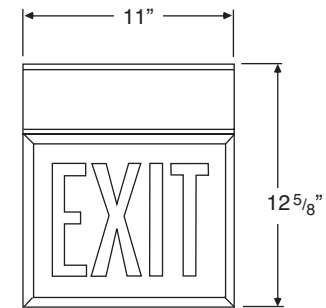

C3-2  
Battery Back-Up  
Front View

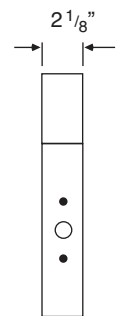

C3-2  
Battery Back-Up  
Side View

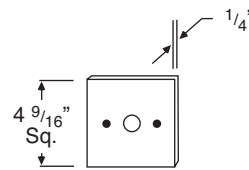

C3  
Canopy

### EMERGENCY OPERATION

Emergency system illuminates lamps when normal (AC) power fails. Fluorescent and incandescent units come complete with 6V, maintenance free Lead Acid battery for (2) hour operation. Cold cathode system utilizes nickel metal hydride battery, providing equal light output in both AC and DC modes. All units offer solid state charger, automatic brownout protection and low voltage disconnect, which prevents overdischarge of battery. A momentary test switch and charge indicating light are standard. Fluorescent signs are furnished with two 3.6 Watt, 6V DC wedge base lamps which illuminate when AC power fails.

# C3

## EXTRUDED ALUMINUM EXIT

### ORDERING INFORMATION

Example: C32221BATP

C3	2	2	2	1	BA	TP
----	---	---	---	---	----	----

Series	Power	Panels	Lamping	Voltage	Finish	Options
C3	1= AC Only 2= Battery Back-up 3= Side Mounted Battery Housing 4= Deep Self-Contained Housing	<b>Single Face</b> 2= Stairs 3= Exit 5= Stairs → 6= Exit → 8= Stairs ← 9= Exit ← 11= Stairs ↔ 12= Exit ↔  <b>Double Face</b> 17= Stairs 18= Exit 20= Stairs → 21= Exit → 23= Stairs ↔ 24= Exit ↔	1= Incandescent 2= Fluorescent 3= (3) 4 watt T4 Fluorescent Lamps 4= Cold Cathode	1 = 120 2 = 277 3 = 120/277 (cold cathode only)	BA = Brushed* Aluminum W = White *= Standard	TP= Tamper Proof Screws LLI= Long Life Incandescent G/W= Green Letters on White EXC= (Dual) Emergency Circuit NCB= Nickel Cadmium Battery FLS= Flasher BZ= Buzzer FAI= Fire Alarm Interface MOD= Special Panel Wording or Panel Color PK= Pendant Kit (specify stem length)



Shown: C34222BA

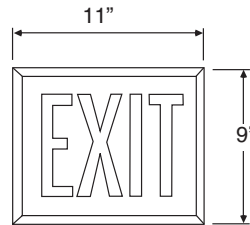

C3-4  
Deep Housing  
Front View

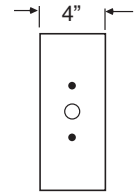

C3-4  
Deep Housing  
Side View

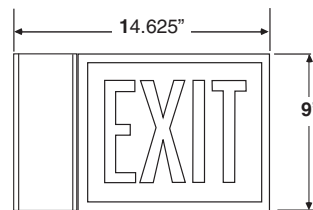

C3-3  
Side Mount Housing  
Front View

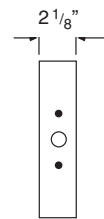

C3-3  
Side Mount Housing  
Side View

NOTE: Specifications and dimensions subject to change without notice

### CODE COMPLIANCE

U.L, E.T.L. or ENTELA Listed. City of Chicago Approved.



### WARRANTY

Any component that fails due to manufacturer's defect is guaranteed for 1 year from time of shipment. Battery is prorated for 5 years. Warranty does not apply to damages caused by improper installation, abuse, fire or acts of God.



p: (877) 305-0898 | f: (310) 305-4646  
theexitstore.com | sales@theexitstore.com